

# BladderScan® BVI 3000

Noninvasive Bladder Volume Instrument



## Operator's Manual

Your Local  
BladderScan®  
Distributor is:

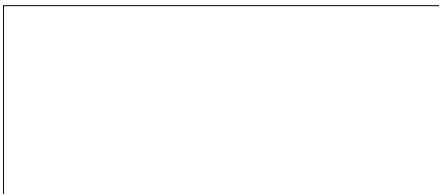

**BladderScan<sup>®</sup> BVI 3000**  
**Noninvasive Bladder Volume Instrument**

**Operator's Manual**

**Caution:** In the United States, federal law restricts this device to use by or on the order of a physician.

Copyright © 2006 by Verathon Inc.

All rights reserved. No part of this User's Guide may be copied or transmitted by any method without the express written consent of Verathon Inc.

BladderScan® and Sontac® are registered trademarks of Verathon Inc.  
Other products and companies named in this User's Guide may be trademarks of their respective companies.

The BladderScan® instrument documented in this manual is protected by U.S. Patent Numbers 4,926,871 and 5,235,985. The Sontac® ultrasound coupling pad described in this manual is protected by U.S. Patent Number 5,782,767. Other international patents pending.

This User's Guide is Verathon™ Part No. 0900-0383.

Information in this User's Guide may change at any time without notice. Examples described or illustrated in this User's Guide are fictitious and do not in any way represent real patient or exam data.

**Verathon Inc.**

21222 30th Drive SE, Suite 120  
Bothell, WA 98021  
800.331.2313 (US and Canada only)  
425.867.1348  
Fax: 425.883.2896

**Verathon Medical (Europe) B.V.**

Boerhaaveweg 1  
3401 MN IJsselstein  
The Netherlands  
+31.30.68.70.570  
Fax: +31.30.68.70.512

**Verathon Medical (Japan) K.K.**

Executive Tower Azabudai 7F  
1-4-3 Azabudai  
Minato-ku  
Tokyo, Japan 106-0041  
+81.03.3560.3501  
Fax: +81.03.3560.3502

**Verathon Medical (United Kingdom) Ltd.**

The Granary Manor Farm Courtyard  
Aston Sandford, Aylesbury  
Buckinghamshire, HP17 8JB  
United Kingdom  
+44.1844.299.207  
Fax: +44.1844.299.218

**Verathon Medical (France) Sarl**

BP 10039  
F-67012 Strasbourg Cedex  
France  
+33.03.88.60.14.12  
Fax: +33.03.88.60.46.87

For additional contact information, please visit our website at [www.verathon.com](http://www.verathon.com).











**CE0123**

0900-0383-09-60

## Technical Description: Battery Charger (continued)

<b>Ventilation</b>	The power supply is designed to operate with free air convection.
<b>Earth Terminal</b>	The earth terminal provided in this unit is a functional earth terminal, as indicated by the ground symbol  on the unit. It is not utilized in the power supply to provide earth protection. Various ground options are available upon request.
<b>Fuses</b>	The fuses used in the power supply are rated at 250V AC, 2A, quick acting.
<b>Cleaning</b>	No cleaning is needed. If desired, a dry or slightly damp cloth may be used to clean the surface of the power supply while it is disconnected from the AC source. In no instance should water be allowed to enter the unit.

## Symbol Directory

	Class II Equipment
	Type BF applied part. To identify a type BF applied part with IEC-60601-1
	CE mark in accordance to the Medical Device Directive
	Canadian CSA Symbol
	Attention, consult accompanying documents
	Battery Pack Reference Part Number #400-0039
	Ambient Temperature, storage conditions
	Atmospheric Pressure, storage conditions
	Relative Humidity, storage conditions
	Ground Symbol, Earth Terminal

## Table of Contents

<b>Important Information</b> .....	4
<b>BladderScan® BVI 3000 Components</b> .....	5
<b>Description of the BladderScan® BVI 3000</b> .....	6
<b>Preparations for Use</b> .....	7
<b>Customizing the BladderScan® BVI 3000</b> .....	9
<b>Operating the BladderScan® BVI 3000</b> .....	11
<b>Verifying Aim</b> .....	13
<b>Printing Results</b> .....	15
<b>Histogram of Cost Savings</b> .....	16
<b>Adding a Patient ID Number and Notes</b> .....	17
<b>Print Options</b> .....	18
<b>Adjusting Preferences</b> .....	19
<b>Additional Features</b> .....	21
<b>Regular Inspection and Maintenance</b> .....	22
<b>Trouble Shooting</b> .....	23
<b>Warranty and Disclaimer Information</b> .....	24
<b>Contacting Verathon Inc.</b> .....	25
<b>Safety and Performance Summary</b> .....	26
<b>Parts and Accessories</b> .....	27
<b>Technical Description</b> .....	27
<b>Technical Description: Battery Charger</b> .....	29
<b>Symbol Directory</b> .....	30

## Important Information

**Product Description** The BladderScan® BVI 3000 is a B-mode ultrasonic instrument, portable and battery operated, intended for the noninvasive measurement of urinary bladder volume. A mechanical sector scanning transducer provides cross-sectional images of the bladder from twelve scan planes. Based on these images, the BladderScan® automatically calculates the estimated bladder volume in milliliters and displays it on a screen.

**Notice To All Operators** The BladderScan® BVI 3000 should be used only by individuals who have been trained and authorized by a physician or the institution providing patient care. All operators should read this manual prior to using the BVI 3000. Failure to comply with these instructions may compromise the performance of the instrument.

**Biological Safety** To date, exposure to pulsed diagnostic ultrasound has not been shown to produce adverse effects. However, ultrasound should be used only by medical professionals when clinically indicated, using the lowest exposure times possible commensurate with clinical utility.

The ultrasonic output power of the BladderScan® BVI 3000 is not user-adjustable and is limited to the minimum level necessary for effective performance. Data on acoustic output levels can be found in the section titled, "Technical Description," in this manual.

**Statement of Prescription** *Caution: United States Federal law restricts this instrument to use by or on the order of a physician.*

**Statement of Intended Use** The BladderScan® BVI 3000 projects ultrasound energy through the lower abdomen of the nonpregnant patient to obtain an image of the bladder, which is used to determine bladder volume noninvasively.

**Warning:** *Not intended for fetal use.*

**Warning:** *Not intended for use on pregnant patients.*

**Warning:** *There is the hazard of possible explosion if the BVI 3000 instrument is used in the presence of flammable anesthetics.*

**Cautions** The BVI 3000 should not be used on a patient with open skin or wounds in the suprapubic region.

The patient should not have a catheter in his/her bladder. This could affect the accuracy of the instrument.

Use care with suprapubic/pelvic surgery patients. Scar tissue, incisions, sutures and staples affect ultrasound transmission and reflection.

Accuracy may be affected for patients with ascites or free floating fluid in the peritoneum.

Verathon Inc., upon written request, will make available circuit diagrams and other technical documentation which will assist the user's appropriately qualified technical personnel to repair this equipment. This information is deemed confidential and proprietary and its use is limited solely to such repair applications. Repair should be performed only by Verathon™ or a Verathon™ authorized service organization.

## Technical Documentation

## Technical Description: Battery Charger

The battery charger (Verathon Part No. 400-0036) can be used with an input of 100-250V~ sat 47 to 63 Hz. Its output is 9v at 1Amp.

Use only the battery charger supplied. Use of any other charger may damage the battery pack.

The battery charger used with the BVI 3000 is tested to IEC 601-1 requirements and is in compliance with UL and CSA equivalent standards.

The power supply is not intended for direct patient contact. The batteries used in the BVI 3000 are charged separate from the control unit and not during patient use.

## Battery Charger

## Certification

The BladderScan® power supply is designed to operate under the following conditions:

Input Voltage: 100-120V AC/North American (LZA-) units, 200-250V AC/European (LZE-) units, 100-250VAC/Universal (LZU-) units.

Input frequency: 50-60Hz.

Input Current: 0.39A/North American (LZA-) units. 0.25/European (LZE-) units. 0.38A/Universal (LZU-) units.

Output: No load to full load at rated voltage. Refer to unit label.

Input Connection: The power supply employs a direct plug in AC prongs for wall plug in units.

Insulation: The power supply is Class I with basic insulation to each terminal.

## Technical Specifications

- Indoor use
- Temperature from +10 to +40 degrees Celsius
- Transient overvoltage: Category II
- Pollution degree II
- Atmospheric pressure 70 hPa to 106 hPa
- Relative humidity 30% to 75%, non-condensed

## Environmental Conditions For Use

## Technical Description (continued)

### Scanning Accuracy

*Note: The accuracy that an individual achieves using the BVI 3000 depends on properly aiming the scanhead so that the bladder falls entirely within the measurement cone.*

Given the tremendous variation of healthy and compromised human anatomy, a guaranteed accuracy specification for the instrument used on humans would be difficult. For this reason, the following accuracy specification assumes usage per instructions, scanning a Verathon™ Tissue Equivalent Phantom:

Bladder Volume Range: 0 to 999 ml  
Accuracy: 0 to 699 ml  $\pm 20\%$ ,  $\pm 20$  ml  
700 to 999 ml  $\pm 25\%$ ,  $\pm 25$  ml

### Environmental Conditions for Storage

Ambient temperature from -20 to +60 degrees Celsius  
Relative humidity of 20% to 95%, non-condensing  
Atmospheric pressure from 500 hPa to 1060 hPa

### Environmental Conditions for Use

Ambient temperature from +10 to +40 degrees Celsius  
Relative humidity of 30% to 75%, non-condensing  
Atmospheric pressure from 700 hPa to 1060 hPa

### Clock/Calendar

The internal clock is accurate to better than one minute per month at 25 degrees Celsius. It will operate for at least 10 years from an internal lithium battery. It knows the number of days in each month and will correctly handle February in a leap year.

### Avoiding or Identifying and Resolving Adverse Electromagnetic Effects

There are no restrictions for the use of the BladderScan® BVI 3000 due to its electromagnetic characteristics. Both the emissions from the BVI 3000, and the susceptibility of the BVI 3000 to interference from other sources, are within prescribed limits of all applicable standards at the date of manufacture. The emissions test procedure used is that specified in EN55011: 1991 for Group 1, Class A equipment (per EN60601-1-2, 36.201.1.7). The BVI 3000 is suitable for use in ISM (industrial, scientific and medical) environments, and in domestic environments under the jurisdiction of a health care professional. An indication of adverse electromagnetic effects from the BVI 3000 on another electronic device would be a degradation of performance in that other device when the BVI 3000 is operated simultaneously. If such interference is suspected, separate the two devices as much as possible, or discontinue simultaneous operation, if practical, and contact Verathon™.

The BVI 3000 will operate normally in the proximity of other potential interference sources, and has demonstrated immunity at a field strength of 3 V/m (per EN60601-1-2, 36.202.2.1). In addition, the BVI 3000 detects outside interference and will display "RESCAN" instead of a volume measurement if detected interference is of sufficient magnitude to possibly compromise measurement accuracy. If this "RESCAN" display occurs repeatedly, attempt to locate and disable or remove the interference source, or use the BVI 3000 away from the interference source. If these efforts do not restore normal operation, contact the distributor.

No other precautions need to be taken regarding exposure in reasonably foreseeable environmental conditions to magnetic fields, pressure or variations in pressure, acceleration, or thermal ignition sources.

## BladderScan® BVI 3000 Components

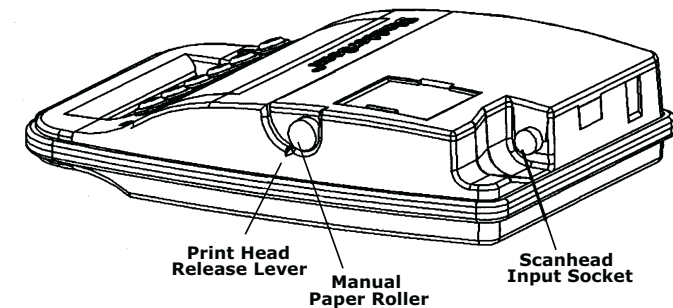
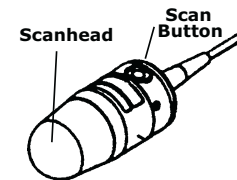
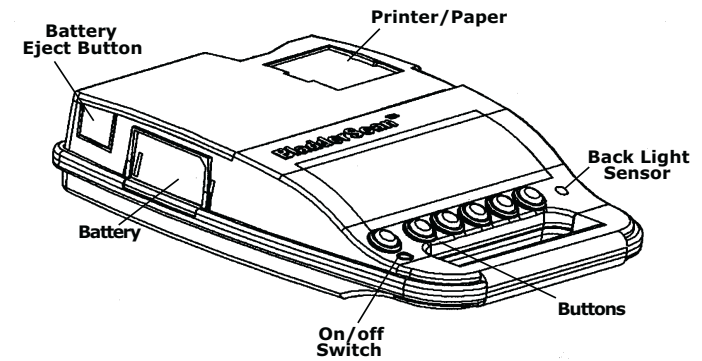

## Description of the BladderScan® BVI 3000

The BladderScan® BVI 3000 consists of 4 main components: The Scanhead, Control Unit, Rechargeable Battery, and Battery Charger.



### Scanhead

The scanhead transmits and receives ultrasound, automatically moving its internal transducer 360° to scan twelve planes and produce a three-dimensional image of the urinary bladder. The scanhead is connected to the control unit by means of a cable.

### Control Unit

The control unit provides all operating controls for the scanning procedure by means of six soft keys. The measured bladder volume and a target-shaped aiming icon are clearly displayed on the LCD screen, helping the operator to achieve accurate measurement results.

### Batteries & Charger

Two NiMH rechargeable batteries are included with the BladderScan® BVI 3000. One battery can be recharged in the battery charger while the other is being used to power the BladderScan®. This ensures that there is no instrument downtime. The charger brings the battery to a full charge in 6 hours or less.

(See picture and instructions for charging the battery on page 7).

## Parts and Accessories

Part Number	Description
0570-0090	BVI 3000 Instrument
0570-0091	Dome Scanhead Assembly
0400-0036	Battery Charger
0400-0039	Battery 7.2V
0800-0166	Carrying Case
0800-0167	Rolling Cart
0800-0005	Acoustic Coupling Gel, 0.25 liter
0800-0042	Printer Paper (5 rolls)
0800-0225	Sontac® Gel Pad Qty. 50
0900-0383	Operator's Manual
0900-0396	Training Video

## Technical Description

Verathon™ certifies that the BladderScan® BVI 3000 is in compliance with all applicable international and national standards and regulations, including, but not limited to, IEC-601-1 (EN60601-1) and EN 60601-1-2; MDD 93/42/EEC Annex 1, CSA22.2 No. 125 (Risk class 2) (LR 76129-1), and UL544. Per the provisions of IEC-601-1, this device is classified as:

### Compliance with Standards

 **Protection Class II, INTERNALLY POWERED EQUIPMENT**

 **TYPE BF, suitable for CONTINUOUS USE**

Per the MDD, the BladderScan® BVI 3000 is a Class IIa device.

The ultrasound output parameters of the BVI 3000 are as follows:

Temporal Average Power:	1 mW maximum
Focal 20 dB Beam-Area:	1.4 cm <sup>2</sup>
Transducer Dimension:	3 mm diameter
Working Frequency:	2 MHz
Peak Instantaneous Intensity:	14 W/cm <sup>2</sup> maximum
Pulse Repetition Frequency:	180 pulses/second

Technical performance assessment (for example, in an acoustic laboratory) may require partial immersion of the scanhead. Immerse the black plastic dome no further than the point at which it connects to the black body.

### Scanning Specifications

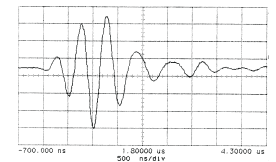

## Safety and Performance Summary

- The BVI 3000 computes the volume of the urinary bladder based upon twelve, cross-sectional ultrasound images. For maximum accuracy, be sure to hold the scanhead motionless while scanning.
- The most accurate measurements are obtained when the patient rests quietly in the supine position.
- Accuracy is compromised if the user does not obtain an optimal, repeatable image.
- Errors in usage tend to result in the underestimation of bladder volume, except in cases where the scanhead is moved during scanning. In this case, the measurement may overestimate the patient's bladder volume.
- The BladderScan® BVI 3000 is not intended for use on pregnant patients.
- The patient being scanned should not have a catheter in his or her bladder. This could create micro bubbles in the bladder, which affect the accuracy of the measurement.
- Do not use the BVI 3000 on patients with open skin or wounds in the suprapubic region.
- Use care when scanning suprapubic and pelvic surgery patients. Scar tissue, surgical incisions, sutures, and staples can affect ultrasound transmission and reflection.
- To conserve power, the BladderScan® BVI 3000 turns off automatically when not in use.
- We recommend that new operators first use the BVI 3000 on patients with moderately full bladders, rather than initially attempting to locate a bladder with a low volume.

**Warning:** There is the possible hazard of explosion if the BVI 3000 is used in the presence of flammable anesthetics.

## Preparations For Use

### Connecting the Scanhead

Connect the scanhead to the input socket at the back of the instrument by aligning the tabs on the scanhead plug with the matching slots on the instrument socket. Press the plug straight in until there is a "click." To remove the plug, grasp the black plastic ring and pull straight out. Do not twist.

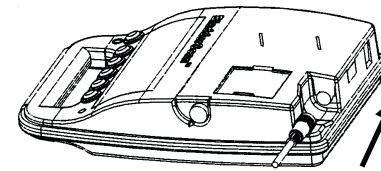

To charge a battery, plug the charger into an electrical outlet. Remove the label covering the battery contacts and slip the battery into the recess on the top of the charger. Fully charging the battery may take up to 6 hours.

Batteries may be stored in the charger. There is no danger of overcharging the battery.

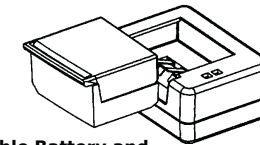

**Rechargeable Battery and Battery Charger**

Check the color indicator lights on top of the battery charger to determine the battery's power status while charging.

**Solid Green:** When the battery is low on charge, charging begins in the fast charge mode. During fast charge mode, the green light is solid. For a fully discharged battery, fast charge mode lasts about two to three hours.

**Quickly Blinking Green:** When the battery reaches 80% of its charge level, the charger starts to "top off" the charge and the green light blinks quickly. At this point, you can use the battery in the BladderScan® instrument.

**Amber Light:** In some cases the charger displays an amber light. The amber light means the battery temperature is stabilizing before recharging can begin. This may occur when the battery is taken from a very cold or warm environment, or if the battery is defective. If the light remains amber for over an hour, the battery is defective and must be replaced.

**Slowly Blinking Green Light:** If the green light blinks slowly upon inserting a battery, then the battery level is too low for fast charging. The charger trickle charges the battery until the power level is high enough to begin fast charging. At this point, fast charging begins automatically.

### Charging Batteries

*Note: The battery life is extended if you wait for about three hours until the battery is fully charged. Verathon™ recommends that you store your spare battery in the charger to prevent instrument downtime due to discharged batteries.*

*Note: Plugging and unplugging the charger while a battery is inserted causes no damage. There is no danger when the charger is plugged in without the battery inserted.*

## Preparations For Use (Continued)

### Installing a Battery

When the battery has been properly charged, install it in the BVI 3000 as demonstrated in the illustration below.

#### Battery release button

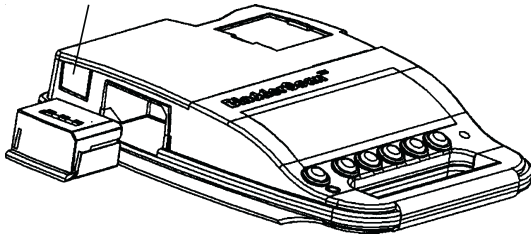

To remove the battery, push the battery release button.

### Battery Icon

The battery icon, located in the upper-right corner of the BladderScan® LCD screen, indicates the power status of the battery currently installed in your instrument. Read the battery icon as follows:



A fully darkened battery icon indicates that the battery is fully charged and ready for use.



A battery icon that is almost full indicates a partially discharged battery.



When the battery icon is half-darkened, the battery is partially discharged. This is the most common display, shown during the majority of the battery's charge life.

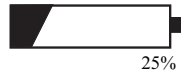

An almost empty battery icon indicates that the battery is nearly discharged. While a few more scans can still be performed, the battery should be replaced at this point.

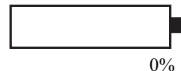

When the battery is fully discharged, the battery icon is completely clear and the BVI 3000 does not work. The discharged battery must be replaced with a charged one.

### Battery Care

The BladderScan® BVI 3000 draws very little power when it is turned off; however, if you do not plan to use your instrument for several weeks, you should remove the battery to prevent it from becoming discharged.

The battery that is not in use should be stored in the charger so it remains fully charged.

## Contacting Verathon Inc.

The team at Verathon Inc. is committed to modernizing healthcare delivery by putting patients first. Our products support healthcare professionals by providing the highest level of accuracy, utility, and excellence. For additional product and company information, visit the Verathon™ web site at [www.verathon.com](http://www.verathon.com). If you have any questions or comments about Verathon™ products and services, please contact us at:

**Verathon Inc.**  
21222 30th Drive SE, Suite 120  
Bothell, WA 98021  
800.331.2313 (US and Canada only)  
425.867.1348  
Fax: 425.883.2896

**E-mail:**  
[customerservice@verathon.com](mailto:customerservice@verathon.com)

**Verathon Medical (Europe) B.V.**  
Boerhaaveweg 1  
3401 MN IJsselstein  
The Netherlands  
+31.30.68.70.570  
Fax: +31.30.68.70.512

**E-mail:**  
[customerserviceEU@verathon.nl](mailto:customerserviceEU@verathon.nl)

**Verathon Medical (Japan) K.K.**  
Executive Tower Azabudai 7F  
1-4-3 Azabudai  
Minato-ku  
Tokyo, Japan 106-0041  
+81.03.3560.3501  
Fax: +81.03.3560.3502

**E-mail:**  
[serviceJP@verathon.com](mailto:serviceJP@verathon.com)

**Verathon Medical (United Kingdom) Ltd.**  
The Granary Manor Farm Courtyard  
Aston Sandford, Aylesbury  
Buckinghamshire, HP17 8JB  
United Kingdom  
+44.1844.299.207  
Fax: +44.1844.299.218

**E-mail:**  
[customerserviceUK@verathon.co.uk](mailto:customerserviceUK@verathon.co.uk)

**Verathon Medical (France) Sarl**  
BP 10039  
F-67012 Strasbourg Cedex  
France  
+33.03.88.60.14.12  
Fax: +33.03.88.60.46.87

**E-mail:**  
[info@verathon.fr](mailto:info@verathon.fr)

## Warranty and Disclaimer Information

### Warranty

Verathon™ warrants the BladderScan® BVI 3000 against defects in material and workmanship for one (1) year from the date of purchase from Verathon Inc. This warranty is given only to the original purchaser of the BladderScan® instrument.

Pursuant to this warranty, a service center authorized by Verathon Inc. will repair or replace products which prove to be defective during the warranty period.

This warranty does not cover equipment sold as used.

This warranty does not apply if the product has been damaged by misuse or as the result of service or modification by anyone other than a service center authorized by Verathon™. The instrument shall be used in accordance to the instructions contained in this *Operator's Manual*.

Consumable items shall be used in conformance with Verathon™ product specifications. Consumable items are not covered under this warranty.

Warranty conditions may differ in some countries. Contact your local distributor for warranty terms.

Warranty extensions are available. For more information, please talk to your local Verathon Medical™ representative, or contact the Verathon Medical™ Customer Care department using the contact information on page 25.

### Disclaimer of Additional Warranties

There are no understandings, agreements, representations of warranties expressed or implied (including warranties of merchantability or fitness for a particular purpose) other than those set forth in the preceding Warranty section. The contents of this *Operator's Manual* do not constitute a warranty.

Some states disallow certain limitations on applied warranties. The purchaser, user and patient should consult state law if there is a question regarding this disclaimer.

The information, descriptions, recommendations, and safety notations in this *Operator's Manual* are based upon Verathon™ experience and judgment, as of August 2006, with respect to the BladderScan® BVI 3000 instrument. This product involves a relatively new area of medical technology. The contents of this *Operator's Manual* should not be considered to be all inclusive or covering all contingencies.

The physician(s) at your institution directing the use of the BVI 3000 instrument is responsible for keeping current with developments in the literature on bladder volume. Please direct any questions or problems concerning bladder volume, the use of the instrument, or interpretation of data, to the responsible physician(s).

## Customizing the BladderScan® BVI 3000

### Programming the Facility Name

You can customize the BladderScan® BVI 3000 instrument by entering your facility name and the current date and time. This information will subsequently be included on all printouts of exam results. To customize the BVI 3000, follow these steps:

- Turn the BVI 3000 on by pressing the button marked: 
- On the Main Menu screen, press the ALT button to display the Alternate Menu screen, illustrated below.\*

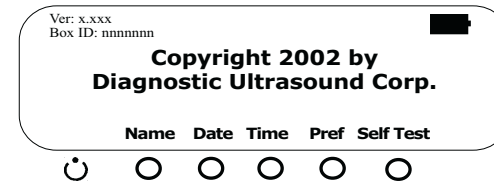

*Note: Diagnostic Ultrasound Corp. is now called Verathon Inc.*

**\*Important:** If your BVI 3000 came with the PIN code option enabled, you must enter your PIN code before you can access the Alternate Menu. The default PIN is "0000." For information about how to personalize the PIN code, see the section titled, "Adjusting Preferences," in this manual.

- Press the NAME button. The Name Preset screen, with a 4 x 13 grid containing alphabetic, numeric, and punctuation characters, is displayed.

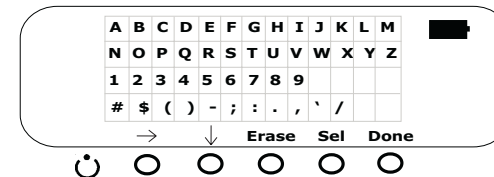

*Note: You may use any combination of up to 27 characters when entering the facility name. For example, you can enter the name of the hospital, clinic, or physician supervising use of the BVI 3000.*

*Note: You can use the empty character as a space to separate words.*

- Use the "arrow right" → and "arrow down" ↓ buttons to highlight the first character you want to enter. (To move horizontally, press the "arrow right" button. To move vertically, press the "arrow down" button).
- When you have highlighted the desired character, press the SEL button to select it. The character(s) you have selected are displayed below the character grid.
- Continue to use the "arrow right," "arrow down," and SEL buttons to enter all the characters in your facility's name. If you make a mistake, use the ERASE button to delete the last character entered.
- When you are finished, press DONE to return to the Main Menu. The programmed facility name will now be displayed on the Main Menu screen.

*Note: When the arrow buttons are held down, the cursor moves one character a second. When the cursor reaches the end or bottom of the grid of characters, it wraps around to the first character again.*

## Customizing the BVI 3000 (Continued)

### Setting the Date

*Note: Once set, the BVI 3000 clock recognizes the number of days in each month, including February during leap years. It has its own lithium battery and maintains the correct date and time for at least ten years, even if the rechargeable battery is removed.*

- On the Main Menu screen, press the ALT button to access the Alternate Menu (if prompted, enter your PIN number). Then press the DATE button.
- The Date Preset screen displays the current setting for the date, in U.S. format (two digits each for the month, day, and year).

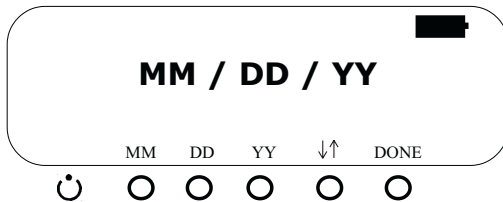

- Press the MM button until the correct month is displayed. Only values from 01 to 12 are allowed (12 is followed by 01).
- Press the DD button until the correct day is displayed. Only values from 01 to 31 are allowed (31 is followed by 01).
- Press the YY button until the correct year is displayed. Only values from 97 to 19 (for 1997 to 2019) are allowed.
- Press  $\downarrow$   $\uparrow$  to toggle between the following options: 1) values are increased, or 2) values are decreased, when the month, day, and year buttons are pressed.
- When the date is set, press DONE to return to the Main Menu screen.

### Setting the Time

*Note: Enter the time in 24-hour format ("military time"). To convert standard clock time to 24-hour format, after 12-noon add 12 hours to the clock time (Example: 3:00pm + 12 hours = 15:00 hours).*

- On the Main Menu screen, press the ALT button (and then enter your PIN code, if required) to access the Alternate menu. Next, press the TIME button. The Time Preset screen displays the time that is currently set.

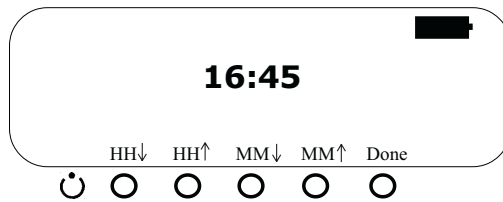

- Press the HH  $\downarrow$  or HH  $\uparrow$  to set the hour.
- Press the MM  $\downarrow$  or MM  $\uparrow$  buttons to set the minutes.
- When the time is set, press DONE to return to the Main Menu screen.

You have now customized your BladderScan® BVI 3000 instrument.

## Trouble Shooting

### Instrument Does Not Turn On

If the instrument does not turn on, this is usually due to a dead or discharged battery and can be fixed simply by replacing the dead battery with a charged one. Check the battery icon in the upper-right corner of the LCD screen. If the battery icon is clear (empty), replace the battery.

When the battery charge is too low to allow normal operation (but not too low to permit operation of the internal circuitry) the BVI 3000 displays the following message: BATTERY CHARGE LEVEL IS TOO LOW FOR INSTRUMENT OPERATION. RECHARGE BEFORE NEXT USE. In this event, the battery must be recharged or replaced with a charged one.

### Battery Recharge Message

The BVI 3000 detects the presence of a scanhead. If no scanhead is connected, when a scan is attempted the instrument displays this image:

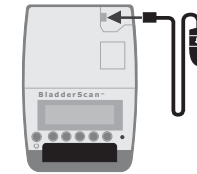

### No Scanhead Message

- When the scanhead is connected, this image disappears and you can proceed to perform a scan.

The BVI 3000 senses the presence of paper and automatically displays this image when the printer is out of paper:

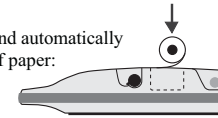

### No Paper

- For instructions on how to load the paper, see the section titled, "Loading Paper," in this manual.

The BVI 3000 senses when the print head is disengaged and displays the following image until the print head release lever is positioned up as far as it can go:

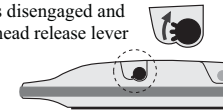

### Disengaged Print Head

The BVI 3000 displays the message "TOO HOT" if the print head overheats. When this message appears, turn off the BVI 3000. This condition may be the result of a paper jam (see the following section for more information).

### Too Hot

If the paper will not advance through the printer, lower the print head release lever (located adjacent to the paper advance thumb wheel). Gently pull the paper backward, while moving the thumb wheel counterclockwise, to clear the paper jam.

### Clearing Paper Jam

**Caution:** If the paper jam is inaccessible, do not try to disassemble the printer. Contact your authorized Verathon™ Service Center or your local Verathon™ distributor for service.

## Regular Inspections and Maintenance

Verathon™ recommends that the BVI 3000 be certified by an authorized Verathon™ Service Center once a year. Certification service includes a comprehensive inspection and testing of the instrument, to ensure accurate measurement performance. For more information, please contact your Verathon™ Service Center or your local Verathon™ distributor.

### Weekly Inspections

Once a week, you should inspect the scanhead and cable for physical faults or cracks. Cracks that allow the leakage or ingress of fluid may affect the performance of the instrument. Any apparent faults or cracks must be referred to your authorized Verathon™ Service Center or your local Verathon™ distributor.

### Monthly Accuracy Check

**Caution:** In the event of changes in the performance of the instrument, discontinue use and contact your authorized Verathon™ Service Center or your local Verathon™ distributor.

Each month, or whenever accuracy assessment is desired, the accuracy of the BVI 3000 should be tested using the following procedure:

- Take a pre-void measurement of bladder volume.
- Void or catheterize into a measurement beaker.
- Take a post-void measurement of bladder volume to check for post-void residual (PVR).
- Subtract the post-void measurement from the pre-void measurement and compare to the voided volume.
- The measured volume should be within a range of  $\pm 20\%$ ,  $\pm 20\text{ml}$  of the voided volume for volumes less than 699ml, or  $\pm 25\%$ ,  $\pm 25\text{ml}$  for volumes larger than 699ml.

### Care, Cleaning and Disinfecting

The BVI 3000 instrument may be cleaned with a soft cloth dampened in isopropyl alcohol.

The round, black, plastic dome of the scanhead can be disinfected with any liquid disinfecting agent suitable for use with LEXAN polycarbonate. In the United States, Cidex and Cidex 7 are FDA-cleared for this purpose. Follow the instructions provided by the manufacturer of the disinfecting agent.

Do not immerse any part of the scanhead or the control unit in a cleaning or disinfecting solution.

Do not use Cidex Plus, as it is not recommended for use with LEXAN polycarbonate.

Do not subject any part of the BVI 3000 instrument to steam sterilization or ethylene oxide sterilization.

Changing gel pads between patients is strongly recommended.

## Operating the BladderScan® BVI 3000

**First Time Users:** We advise new operators to use the BladderScan® BVI 3000 on patients with moderately full bladders, rather than initially attempting to locate nearly empty bladders. An in-service training video has been supplied with your BVI 3000. We recommend that you view the video to supplement the information in this manual with an actual demonstration of BladderScan® use.

- Turn on the BVI 3000 by pressing the button marked: 

The Main Menu screen is displayed.

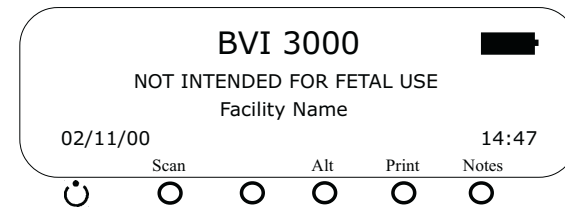

- From the Main Menu, press the SCAN button to go to the Scanning screen.

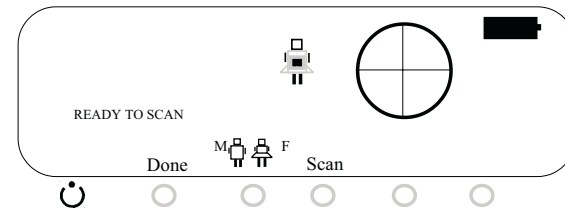

- Press the Male/Female button to select the patient gender. The LCD screen shows a male or a female icon to indicate the gender that is selected. Use the female option ONLY for women who have NOT undergone a hysterectomy (the "Female" option allows the instrument to exclude the uterus from the measurement, which may resemble the bladder ultrasonically). For all other patients, use the "Male" option.

- Clean the rounded end of the scanhead by wiping it gently with a cleaning pad dampened in isopropyl alcohol or a hospital disinfectant solution.

### Turning On

**Note:** If the calibration due date for your BVI 3000 has passed, the message "Calibration Due" will appear every time you turn on the instrument. You can still measure bladder volume; however, this message will continue to appear until an authorized Verathon™ Service Center calibrates the instrument. Press OK to continue.

**Note:** The Scanning screen may also be selected by pressing the scan button on the scanhead. This is especially practical when the scanhead is already positioned on the patient's abdomen.

### Selecting Gender

### Preparing the Scanhead

## Operating the BVI 3000 (Continued)

### Applying the Sontac® Ultrasound Gel Pad

The Sontac® Ultrasound Gel Pad is a convenient and easy-to-use coupling medium designed for use with the BladderScan®. To apply the Sontac® Ultrasound Gel Pad, peel back the foil lid of the individual gel pad package, exposing the gel pad. Palpate the patient's symphysis pubis (pubic bone) and place the Sontac® Gel Pad immediately superior to the patient's symphysis pubis, as shown in the images below.

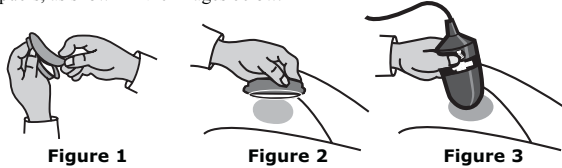

### Using Ultrasound Gel

Sometimes it may be necessary to use liquid ultrasound transmission gel (for example, on obese patients or patients with excessive amounts of body hair). When using liquid ultrasound transmission gel, apply a generous amount on the round dome of the scanhead. Smooth the gel out and remove any air bubbles, which may block ultrasound transmission.

### Measuring Bladder Volume

*Note: While scanning, avoid making any changes in the position, angle or pressure of the scanhead.*

- Locate the patient icon  on the scanhead and make sure the head of the icon will point toward the head of the patient when you place the scanhead on the patient's abdomen.
- Palpate the patient's symphysis pubis and place the scanhead midline on the patient's abdomen, approximately 1.5 inches (4 cm) superior to the symphysis pubis (see illustrations below). Or, if using Sontac® Gel Pads, simply place the scanhead on the gel pad.

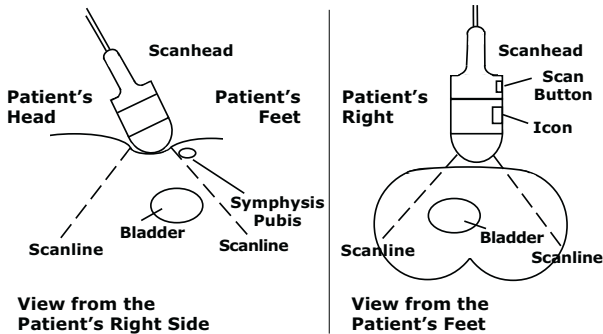

- Aim the scanhead so the ultrasound is projected toward the expected location of the bladder. For most patients, this means aiming the tip of the scanhead toward the patient's coccyx.

- Press and release the scan button, located on the scanhead. 

Hold the scanhead steady throughout the scan. The scanhead clicks once at each scanplane. When you hear a beep, the scan is complete. The Aiming screen is then displayed.

## Additional Features

### Self-Test

To perform an instrument test, go to the Main Menu and press the ALT button (then enter PIN code if required) to access the Alternate Menu. From the Alternate Menu, press the SELF TEST button. The instrument then performs the following tests:

- ROM TEST - Program Memory
- BUS TEST - Microprocessor Bus
- NVRAM TEST - Non-Volatile Battery Backed Memory
- SRAM TEST - Main Memory
- FLASH TEST - Flash Memory

Parameter	Range & Values	Description
<b>Printout</b>	ADD_WALLS (default)	ADD_WALLS = Print grayscale B-mode images with bladder walls highlighted.
	NO_IMAGES	NO_IMAGES = Do not print any B-mode images.
	RAW_ONLY	RAW_ONLY = Print grayscale B-mode images without identifying bladder walls.
	WALLS_ONLY	WALLS_ONLY = Bladder outline only.
	12_PLANES	12 PLANE = All 12 scan planes, printed as in the ADD_WALLS mode.
<b>UTI_rate</b>	0-100, (default=3%)	Percentage of catheterizations which result in UTI; used in cost savings calculations.
<b>UTI_cost</b>	0-2000, (default=\$680)	Cost to treat a UTI; used in cost savings calculations.
<b>Cath_cost</b>	0-20, (default=\$3)	Cost of a catheter; used in cost savings calculations.
<b>Cath_vol</b>	0-1000ml, (default=300ml)	Bladder volume below which catheterization is unnecessary; used in cost savings calculations.
<b>Flash</b>	ON (default)	ON = Flash memory is enabled and scans are saved even if power is removed.
	OFF	OFF = Scan information is not retained if unit is turned off; however, processing time is slightly faster.
<b>Time Zone</b>	GMT ± 0-12	This function currently not used.
<b>Contrast Adjust</b>	30-63, (default=57)	Adjust display contrast ratio; the higher the value, the darker the background.  <i>Note: An immediate effect is seen only when adjusting the contrast value up. Adjusting contrast down is not visible until the instrument is turned off and then on again.</i>
<b>Currency</b>	\$ € £ ¥ (default=blank)	Set the currency for calculating cost savings. Choose US dollars, Euros, Pounds, or Yen. When a different currency is selected, calculations are not affected.
<b>Scan Count Screen</b>	# of scans performed	Selecting this option allows the user to monitor instrument usage. There are two scan counters; one is resettable and one is not. Press "Clear Count" to reset the resettable counter to zero. Only a qualified Verathon™ Service Center can reset the "non-resettable counter" to zero.
<b>Reset Histogram</b>		Allows the user to reset the histogram to begin a new analysis of cost savings.
<b>Change PIN</b>		Selecting this option takes the user to a separate screen to personalize or change the PIN code. The current PIN is displayed. Enter a new PIN and then press "DONE."  <i>Important: Remember your PIN code. If your existing PIN is forgotten, only a qualified Verathon™ Service Center can reset the PIN code.</i>

## Verifying Aim

### Aiming Screen

The greatest measured bladder volume is displayed in large type in the upper left-hand corner of the Aiming screen. Also displayed are the target-shaped Aiming Icon, the instrument status (READY TO SCAN), and the current volume measurement.

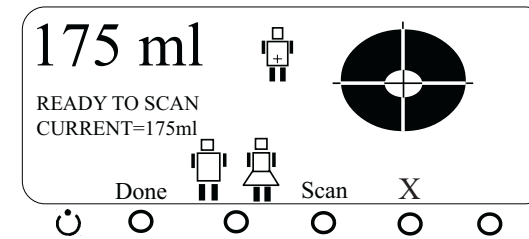

The BVI 3000 always displays two volumes; the **largest volume measured** and the **current volume**.

### Largest Volume and Current Volume

We recommend that you take several measurements to ensure maximum accuracy. The BVI 3000 assumes that the largest volume measured is the true bladder volume, because in most cases the largest volume is the most accurate. Exceptions occur when the operator moves the probe during the scan, or fails to select the female gender when required. In these situations, the largest volume measurement may be higher than the actual bladder volume, and the operator should clear the aiming screen before rescanning the patient.

### Clearing the Screen

To clear the scan results screen, press the clear button, which is labeled with an "X" on the LCD screen. If your instrument does not have a clear button, clear the screen by pressing the DONE button and then pressing the SCAN button to start over. Then rescan your patient. In the following section, we explain how to ensure maximum accuracy by adjusting your aim.

### The Aiming Icon

The light area inside the target-shaped Aiming Icon represents the position of the bladder relative to the scanhead. Accurate results are obtained when the bladder image is centered on the crosshairs of the Aiming Icon. If the bladder is not centered, re-aim the scanhead and rescan the patient. Repeat until the image is properly centered (see Figure 1).

### Adjusting Aim

The Aiming Icon displays the bladder as viewed when looking down on the patient's abdomen. To adjust your aim, slightly move or angle the scanhead toward the direction of the bladder image on the Aiming Icon (target). For example, if the bladder image is located on the right side of the icon, aim the scanhead so the ultrasound will be projected further to the right.

In Figure 1, the bladder image is centered on the crosshairs of the Aiming Icon. This indicates that the scanhead was properly aimed and the bladder volume measurement is accurate.



Figure 1

## Verifying Aim (Continued)

### Adjusting Aim (Continued)

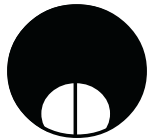

Figure 2

In Figure 2, the bladder image is not centered on the crosshairs; the bladder overlaps one side of the Aiming Icon. This indicates that the scanhead was not properly aimed and part of the bladder was outside its field of vision. In such cases, the measured volume is lower than the true bladder volume. The BVI 3000 recognizes this condition and displays a > (greater than) symbol before the bladder volume measurement. To achieve an accurate measurement, the operator should re-aim the scanhead toward the bladder image and repeat the scan.

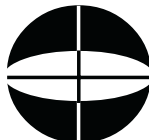

Figure 3

In Figure 3, the bladder overlaps two sides of the Aiming Icon. This indicates that the bladder is too large to be fully contained within the scanhead's field of vision. The BVI 3000 recognizes this condition and displays a > (greater than) symbol before the bladder volume measurement. In such cases, repositioning or re-aiming the scanhead will do little to improve accuracy; however, this situation arises almost exclusively in patients with very large bladder volumes. At these high volumes, measurements are clinically useful even if they underestimate the true bladder volume.

When you are satisfied that the scanhead was aimed properly and the measured bladder volume is accurate, press the DONE button. A Scan Results screen is then displayed.

### The Scan Results Screen

*Note: The longitudinal scan plane is marked by a gender icon bisected by a vertical line. The horizontal scan plane is marked by a gender icon bisected by a horizontal line.*

The Scan Results Screen displays the longitudinal and horizontal scan planes from the **largest image** taken during the exam. The light areas represent the bladder. The dark, triangular surfaces, called scan planes, represent the scanhead's field of vision. The volume measurement is accurate when the light colored bladder images are completely contained within the dark, triangular scan planes.

If the light surface in either scan plane is overlapping the edge of the black area, or appears to be cut off, then part of the bladder was not contained in the scanhead's field of vision and the measurement may underestimate the patient's bladder volume. Press the SCAN button to clear the results of the last scan and return to the Scanning screen. Reposition the scanhead and repeat the scanning procedure.

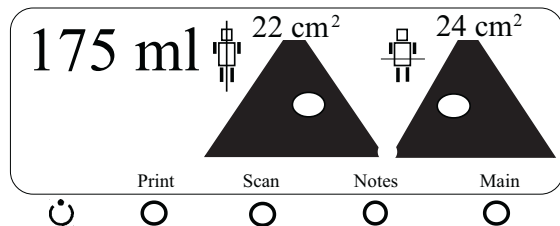

When the bladder images are completely contained in both scan planes, the measurement results are accurate. Pressing either the PRINT or MAIN button completes the scanning procedure and stores the measurement results in the instrument's memory.

## Adjusting Preferences

### Adjusting Preferences

*Note: If your BVI 3000 came with the PIN code option enabled, you must enter your PIN code before you can access the Alternate Menu.*

Various BVI 3000 operating parameters can be customized for individual use via the preference screen. To access the Preference screen and adjust your instrument settings, go to the Main Menu and then press "ALT" to access the Alternate Menu. (If required, enter your PIN code to access the Alternate Menu. See the section below titled, "The PIN Code Option," for more information.) Then press the "PREF" button.

On the Preference screen, a list of adjustable parameters is displayed. Use the SEL ↑ and SEL ↓ buttons to select a parameter. Use the "+" and "-" buttons to adjust the parameter value. Press DONE to save the new setting. For a description of the adjustable parameters, see the table below.

If the PIN code option is enabled, users must enter a PIN code in order to access the Alternate Menu and change instrument settings. This prevents unauthorized users from changing the instrument settings. The default PIN code is "0000." Enter this default code the first time you access the Alternate Menu.

To personalize your PIN code, select the change PIN option on the Preference screen. The current PIN is displayed. Enter a new PIN and then press DONE.

**Important:** Remember your PIN code. If your existing PIN code is forgotten, only a qualified Verathon™ Service Center can reset the PIN code.

### The PIN Code Option

### Personalizing the PIN Code

Parameter	Range & Values	Description
<b>Backlight</b>	AUTO (default) ON OFF	AUTO = Backlight turns on and off automatically, depending on ambient light conditions. ON = Backlight always on. OFF = Backlight always off.
<b>Beep Volume</b>	0-9 (default=5)	Allows user to adjust sound volume (lower values are quieter).
<b>Language</b>	ENGLISH (default) DANISH DUTCH FINNISH FRENCH GERMAN ITALIAN NORWEGIAN PORTUGUESE SPANISH SWEDISH TURKISH	Specifies the language which will be used on the display and local printout.
<b>Date</b>	MM/DD/YY (default) DD/MM/YY YY/MM/DD	Allows the format in which the date is displayed (order of month, day and year) to be adjusted.

(continued on next page)

## Print Options

The Print screen can be accessed by selecting PRINT, either from the Main Menu screen or from the Scan Results screen after a scan is completed. The following table describes the different print options. From the Print screen, use the “SEL” button to select a print option. An X appears in front of the option selected.

Option	Description
<b>Last Image</b>	This option prints the most recent measurement data on the built-in thermal printer. Different types of images can be selected from the Preference screen, using the “Printout” option. (The default is B-mode grayscale images with highlighted bladder walls).
<b>Cost Savings</b>	This option is used to print a Histogram of Cost Savings based on the volume history of the instrument. Cost savings are calculated based on the catheter and UTI costs avoided due to BVI 3000 use. For details, see the section titled, “Histogram of Cost Savings,” in this manual. Histogram settings can be changed in the Preference Menu (for instructions, see the section titled, “Adjusting Preferences,” in this manual).
<b>Test Print</b>	Select this option to test if the built-in thermal printer works. Alphanumeric characters and a simple grayscale test pattern are printed out.

## Loading Paper

**Tip:** To verify that you are loading the paper with the thermal side down, flick your nail over the paper. If a black mark appears, this is the thermal side.

The BVI 3000 has an automatic paper loading mechanism. To load a new roll of paper, open the paper well door at the top of the instrument and insert the end of a new paper roll, with the thermal side down, into the paper input slot. The BVI 3000 senses the presence of the paper and feeds automatically (paper is forwarded through the paper eject slot in the top of the instrument).

It is important that you feed a *straight edge* into the paper feed mechanism. Cut off the first inch of a new paper roll before loading the paper.

**Caution:** To avoid paper jams, never fold the end of the paper roll or cut it diagonally or to a point.

**Caution:** If the paper does not advance, or it appears to be stuck in the printer, turn off the instrument. Lower the printhead release lever, located adjacent to the paper advance thumb wheel. Gently pull the paper backward while moving the thumb wheel counterclockwise. If the paper jam is inaccessible, contact your authorized Verathon™ Service Center or local Verathon™ distributor for service.

## Printing Results

If a printout of the scan result is desired, press the PRINT button to open the Print Menu. The Print Menu is shown below.

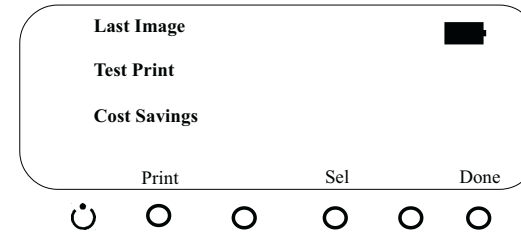

Press PRINT to obtain a printout of the most recent exam. Printing takes about one minute. See Figure 4 for an illustration of the printout.

More information about printing can be found in the “Print Options” section of this manual. During printing, the message, “Printing in Progress,” is displayed. If you need to stop a print in progress, press the ABORT PRINT button.

**Note:** If the facility name, date, and time have not been set, those lines will be skipped on the printout. The BVI 3000 prints on thermal paper. Over time, the thermal printout will fade. For maximum storage life, we recommend that you photocopy the printout.

Figure 4

<b>BladderScan®</b>	
User Name (27 Chars Max)	
MM-DD-YY	
HH:MM	
Bladder Volume = XXXml	
Male/Female Patient Name:	
Patient ID:	
Procedure Code:	
Signature:	
	Longitudinal Axis Area L = XX cm <sup>2</sup>
	Horizontal Axis Area Area H = XXcm <sup>2</sup>
TEAR TO BACK	

## Histogram of Cost Savings

*Note: The default settings can be changed in the Preference screen to reflect the rates and costs at your facility. For more information, see the section titled, "Adjusting Preferences," in this manual.*

*Note: For reference articles on UTI Rate and UTI Costs, see the section titled, "For Further Information," in this manual.*

Figure 5

HISTOGRAM	
Volume	# of Scans
000-099	870
100-199	1,219
200-299	589
300-399	488
400-499	252
500-599	176
600-699	154
700-799	87
800-899	69
900-999	5
>1000	4
Catheterizations Avoided: 2089	
UTIs Avoided: 63	
Savings: \$49,107	

Each volume measurement from a completed scanning procedure is stored in the instrument's memory. Measurement data is stored in one of eleven volume ranges (each with a 100ml increment). This data is analyzed and can be printed at any time in a Histogram of Cost Savings (see Figure 5).

### Cost savings are calculated based on the following criteria:

Catheterizations Avoided - Urinary catheterization below a certain volume is deemed unnecessary. Thus, by using the BVI 3000, these catheterizations are avoided. The default setting (for volume below which catheterization is unnecessary) is 200ml.

UTI's Avoided - Studies indicate that a certain percentage of catheterizations lead to urinary tract infections (UTI's). By avoiding unnecessary catheterizations, the resulting UTI's may be prevented. The default setting (for percent of catheterizations leading to UTI's) is 3%.

### Associated Costs:

Cost of UTI's Avoided - Literature suggests that the additional costs associated with treating UTI amount to \$680.00 per patient infection. The default setting is \$680.00.

Cost of Catheter Kits - The default setting is \$3.00 (per kit).

### Total Cost Savings as a Result of Using the BVI 3000:

$(\text{Caths Avoided} \times \text{Catheter Costs}) + (\text{UTI's Avoided} \times \text{UTI Costs})$

## Adding a Patient ID Number and Notes

A patient ID number (maximum 10 digits) can be added to the scan result and will be included on the printout. To add a patient ID number, press the button marked with a # symbol on the Scan Results screen. The screen displays 0000000000.

- Use the ← (arrow left) and → (arrow right) buttons to select the digit you want to change (the selected digit is underlined).
- Use the + (plus) or - (minus) buttons to select the correct number.
- Continue to use the ← (arrow left) and → (arrow right) buttons and the + (plus) or - (minus) buttons to enter all the digits of the patient ID number.
- When the patient ID number has been entered, press the DONE button to return to the Scan Results screen.

The patient ID number will be included on the printout of the scan.

After a scanning procedure has been completed, it is possible to annotate the measurement results. Press the button marked NOTES on the Scan Results screen. When the Notes option is selected, notes appear on the printout of the exam data.

The operator can change the following settings to annotate the exam:

### Exam Type

Default settings:

- If the measured bladder volume is less than 100ml, the BVI 3000 assumes the measurement was taken after patient voiding and "POSTVOID" is displayed on the screen.
- If the measured bladder volume is between 100ml and 400ml, the BVI 3000 assumes the measurement was taken prior to patient voiding and "PREVOID" is displayed on the screen.
- If the measured bladder volume is greater than 400ml, the BVI 3000 assumes the measurement was taken prior to patient voiding and the bladder was filled to maximum capacity. "CAPACITY" is displayed on the screen.

If the default does not apply, the Exam Type setting can be changed by pressing the EXAM TYPE button to toggle between options. The selected exam type will appear on the right side of the LCD screen.

### Action Taken

Using the SEL↓ button, you can also note the action taken as a result of the current bladder volume measurement. Possible selections are:

- No Action: The default selection
- Patient Voided: The patient was able to void
- Patient Catheterized: The patient's bladder was emptied using a urinary catheter
- Allowed to Fill: The patient's bladder was not as full as desired and voiding was postponed

### Adjusting Volume

The instrument assumes that the amount of urine voided or catheterized is equal to the volume measured by the BVI 3000 (rounded to the nearest 10ml). This value can be adjusted up or down using the buttons labeled "+" and "-".

### Adding a Patient ID Number

*Note: Only press the button marked # when a patient ID number is required. If the # button is used and no patient ID number is entered, the BVI 3000 will assume a patient ID number was entered and 0000000000 will be printed on the printout.*

### Adding Notes